

P	LTR	DESCRIPTION	DATE	DWN	APVD
	A	INITIAL CREATED	09MAR2020	CL	RS
	A1	ECR-15-001339	18MAY2020	CL	SZ

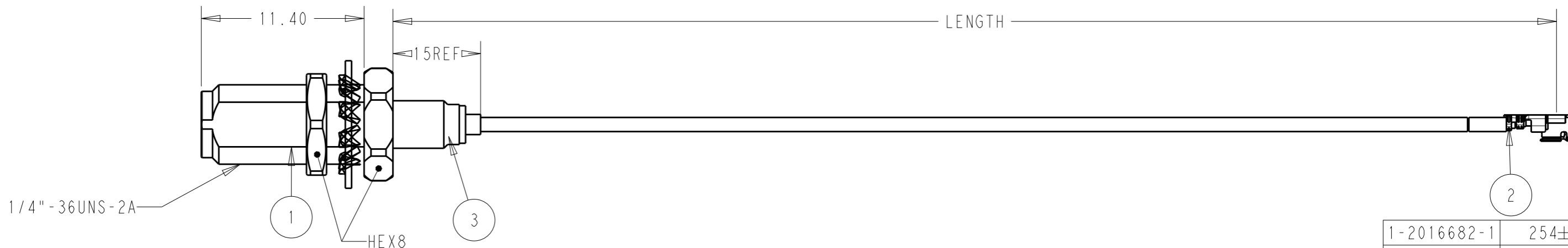
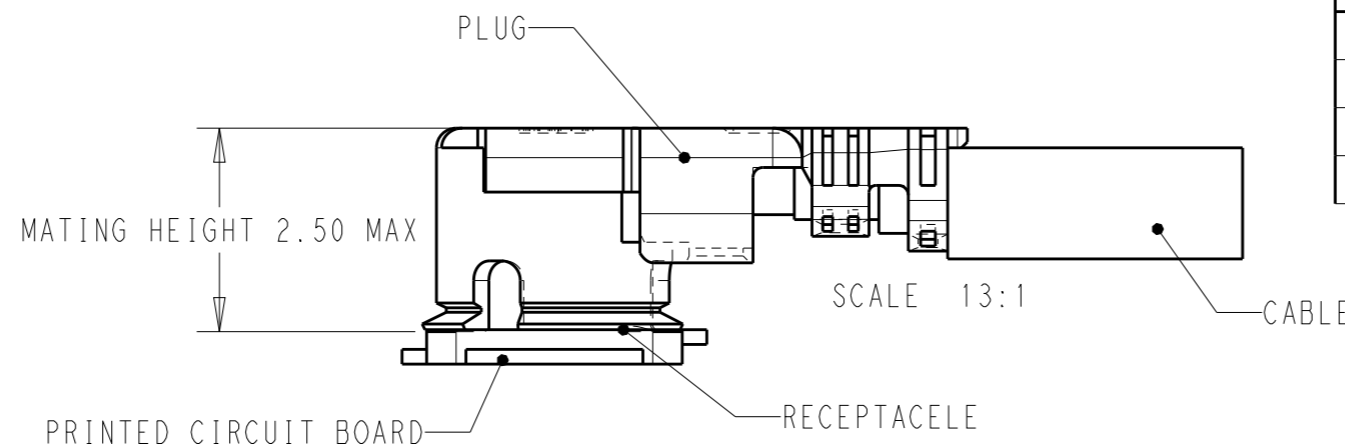
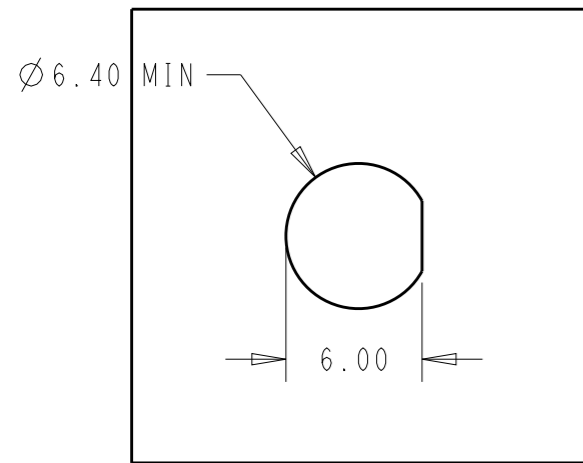

1-2016682-1	254±3
1-2016682-0	1000±10
2016682-9	750±5
2016682-8	500±5
2016682-7	350±5
2016682-6	300±3
2016682-5	250±3
2016682-4	200±3
2016682-3	150±3
2016682-2	100±3
2016682-1	50±3
PART NUMBER	LENGTH

- NOTES:
- MATERIAL AND PROCESSING MUST MEET REQUIREMENTS OF TEC-138-702
 - SMA BULKHEAD NEED ASSEMBLY NUT AND WASHER
 - PRODUCT RATING:
 TEMPERATURE: -45°C TO +85°C
 VOLTAGE: 30V (RMS)
 CHARACTERISTIC IMPEDANCE: 50 OHMS Normal
 FREQUENCY RANGE: DC TO 6GHz
 BEND RADIUS: 5MM MIN
 - CABLE ASSEMBLY TO BE 100% SI TESTED
 VSWR:
 1.3:1 MAX @ DC~1000MHz
 1.5:1 MAX @ 1000~4000MHz
 2.0:1 MAX @ 4000~6000MHz
- INSERT LOSS: (2.60*LENGTH+0.4)dB MAX @2GHz
 LENGTH UNIT IS METER IN THE FORMULA
- SMA INTERFACE FOLLOW IEC 60169-15
 UMCC GEN1 CAN MATE WITH I-PEX MHF SERIES AND HIROSE U.FL SERIES

PC	Q'TY	UNIT	DESCRIPTION	ITEM
PC	1		HEAT SHRINK TUBE	3
PC	0.5		RF CA,UMCC GEN1 BOTH END, WITH 1.13CABLE	2
PC	1		SMA BULKHEAD, FOR 1.13 CABLE	1

THIS DRAWING IS A CONTROLLED DOCUMENT.		DWN 25MAR2019 Cedar Liu		
DIMENSIONS: mm		CHK 26MAR2019 Cedar Liu		
TOLERANCES UNLESS OTHERWISE SPECIFIED:		APVD 09MAR2020 Roger Song	NAME RF CA,SMA BK TO UMCC GEN1 1.13	
0 PLC ±-		PRODUCT SPEC -	SIZE A3	
1 PLC ±0.5		APPLICATION SPEC -	CAGE CODE 00779	DRAWING NO C-2016682
2 PLC ±0.13		WEIGHT -	RESTRICTED TO	
3 PLC ±0.013		RESTRICTED CUSTOMER	SCALE 1:1	SHEET 1 OF 1
4 PLC ±0.0001				REV A1
ANGLES ±-				
MATERIAL TBD	FINISH -			
	finish_spec_2			

Mouser Electronics

Authorized Distributor

Click to View Pricing, Inventory, Delivery & Lifecycle Information:

[TE Connectivity:](#)

[2016682-2](#)